

VÁLVULA BORBOLETA LUG

FURAÇÃO
DIN PN10 /
150 LBS

MINC-1140L

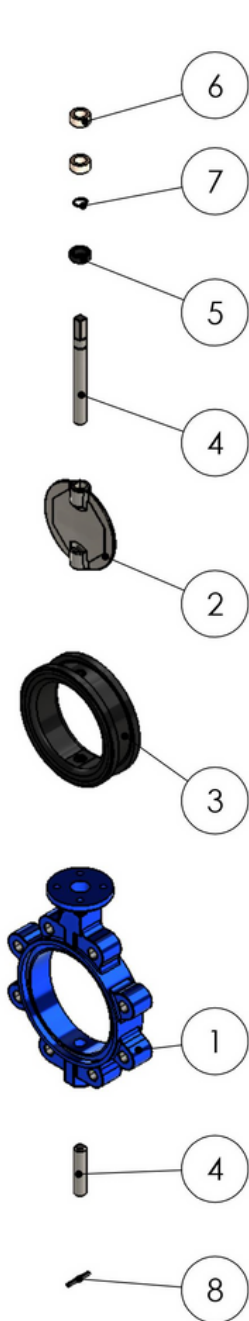

1 - CORPO
FºFº NOD. ASTM A536 GR. 65-45-12/04
BRONZE INDUSTRIAL ASTM B-62-09
BRONZE ALUMÍNIO ASTM B148 C95200 / C95800
AÇO CARBONO ASTM A216 GR. WCB REV. 07
AÇO INOX ASTM A351 GR. CF8 REV. 06
AÇO INOX ASTM A351 GR. CF8M REV. 06

2 - DISCO BORBOLETA
FºFº NOD. ASTM A536 GR. 65-45-12/04
BRONZE INDUSTRIAL ASTM B-62-09
BRONZE ALUMÍNIO ASTM B148 C95200 / C95800
AÇO CARBONO ASTM A216 GR. WCB REV. 07
AÇO INOX ASTM A351 GR. CF8 REV. 06
AÇO INOX ASTM A351 GR. CF8M REV. 06

3 - VEDAÇÃO
EPDM
BUNA-N
VITON
NEOPRENE
SILICONE
HYPALON
TEFLON *
SBR

4 - HASTE
AÇO INOX AISI 410 - ASTM A276/06
AÇO INOX AISI 304 - ASTM A276/06
AÇO INOX AISI 316 - ASTM A276/06

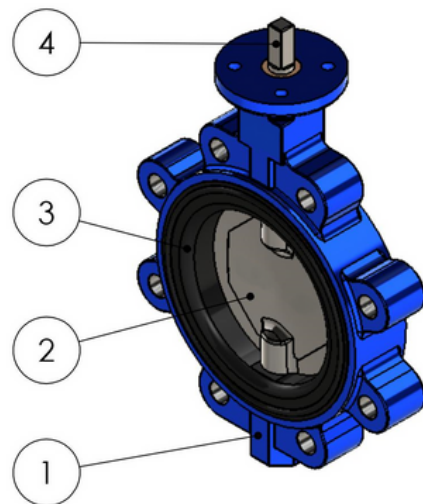

* Montagem em Corpo Bi-partido

TIPOS DE ACIONAMENTOS

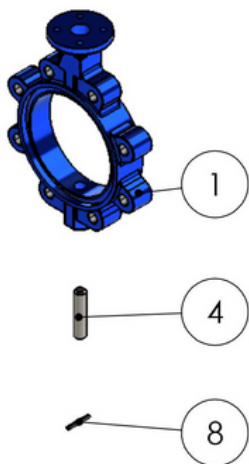

ALAVANCA

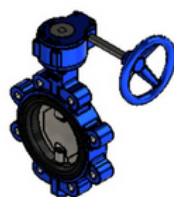

CAIXA REDUTORA



ATUADOR PNEUMÁTICO
RETORNO MOLLA



ATUADOR PNEUMÁTICO
DUPLA AÇÃO

5	RETENTOR	IDEM VEDAÇÃO
6	BUCHA DE RETENÇÃO	CELERON
7	ANEL ELÁSTICO	AÇO GALVANIZADO
8	PINO ELÁSTICO	AÇO GALVANIZADO

VÁLVULA BORBOLETA LUG

FURAÇÃO
DIN PN10 /
150 LBS

MINC-1140L

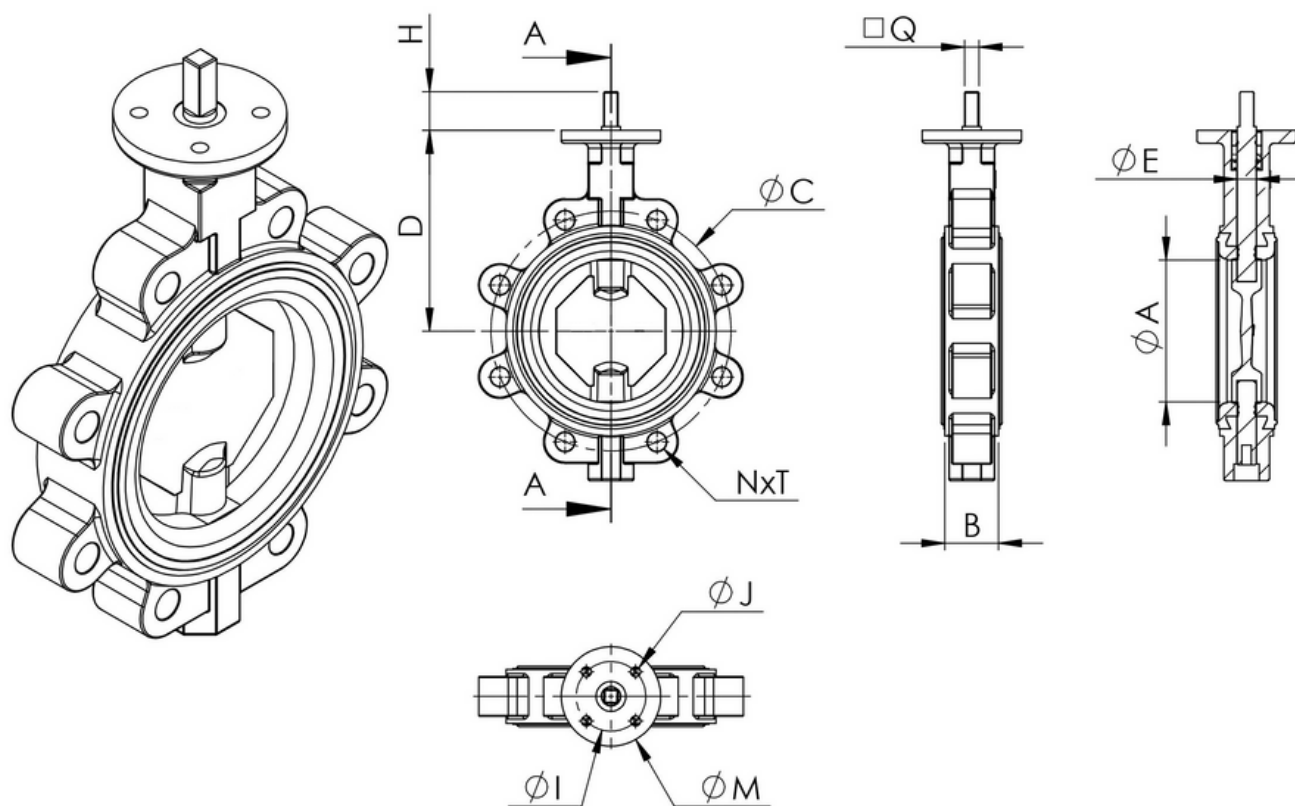

DN	A	B	D	H	E	Q	M	I	J	C	N	T
1½"	45,5	30	100	40	3/8"	11	100	70	4xØ10	110	4	M16
2"	51	41	140	40	9/16"	11	100	70	4xØ10	125	4	M16
2½"	65,5	44	152	40	9/16"	11	100	70	4xØ10	145	4	M16
3"	76	44,5	159	40	9/16"	11	100	70	4xØ10	160	8	M16
4"	101	52	178	40	5/8"	11	100	70	4xØ10	180	8	M16
5"	127	54	190	40	3/4"	14	100	70	4xØ10	210	8	M16
6"	146,5	54	202	40	3/4"	14	100	70	4xØ10	240	8	M20
8"	194	63,2	242,5	50	7/8"	17	130	102	4xØ12	295	8	M20
10"	247	64	278	50	1"	22	130	102	4xØ12	350	12	M20
12"	301	75	310	50	1.1/8"	22	130	102	4xØ12	400	12	M20
14"	337	75	310	50	1.3/8"	27	160	125	4xØ14	460	16	M20
16"	384	100	345	50	1.5/8"	27	160	125	4xØ14	515	16	M24
18"	438	108	370	52	1.3/4"	36	200	140	4xØ18	565	20	M24
20"	491	123	400	52	1.3/4"	36	200	140	4xØ18	620	20	M24
24"	614	151	500	63	2.1/4"	46	230	165	4xØ22	725	20	M27
28"	680	165	560	63	1.7/8"	36	230	165	4xØ22	840	24	M27

CARACTERÍSTICAS:

NORMA DE CONSTRUÇÃO CONFORME API 609 A
NORMA DE TESTE CONFORME API 598/2009

FICHA TÉCNICA - DIMENSIONAL

minc.ind.br | vendas@minc.ind.br

MINC